

Varenummer: 204080M1260A3S
 Beskrivelse: E+G Justerfod
 GN 40-80-M12-60-A3-S
 Note: S Uden møtrik, udvendig sekskant i bunden

Mål

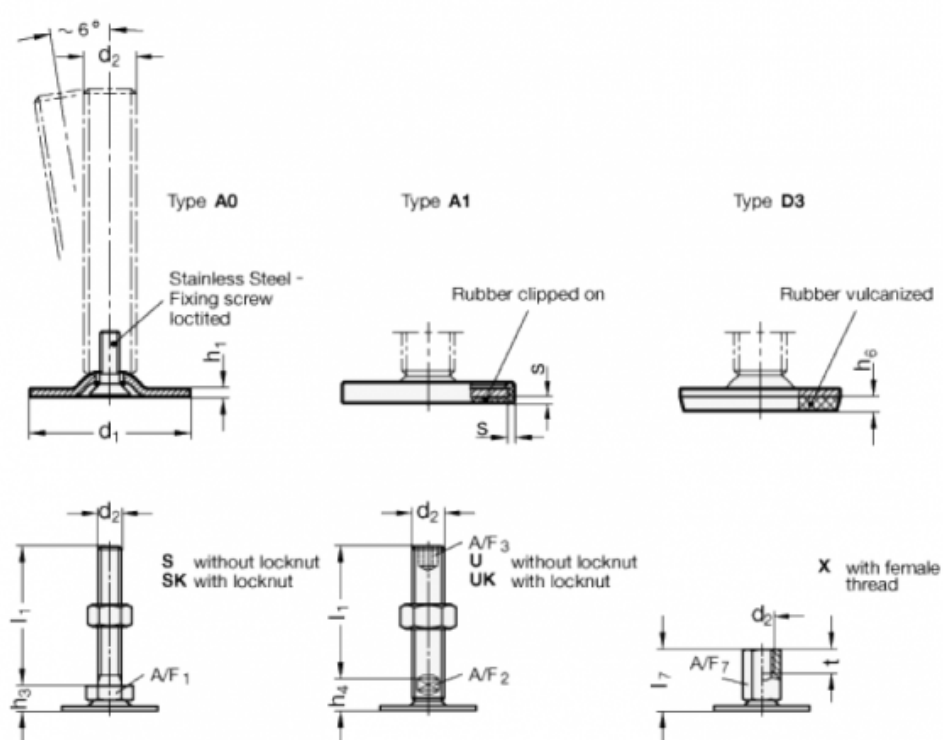

A/F1	= 17
d1	= 80
d2	= M12
h1	= 3
h3	= 12
h6	= 5
l1	= 60
s	=